

magnet-Box combines a metal chassis and power strip, containing sockets and multimedia ports adjusted to the client needs. It's a perfect solution for individual workplace and might be an elegant element of every executive office desk. While being built-in the table top, it allows to plan the working space sufficiently. It's also ergonomic thanks to the brush which enables the usage in open and close position.

Available in different RAL colours, but also INOX and chrome versions, **magnet-Box** gives a lot of arrangement opportunities.



open position



closed position

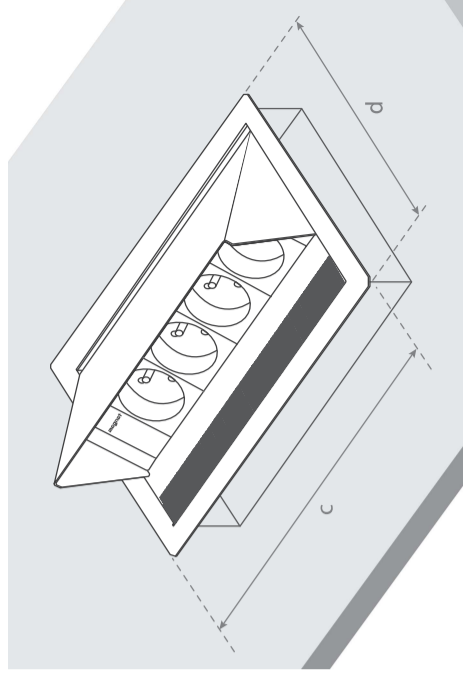
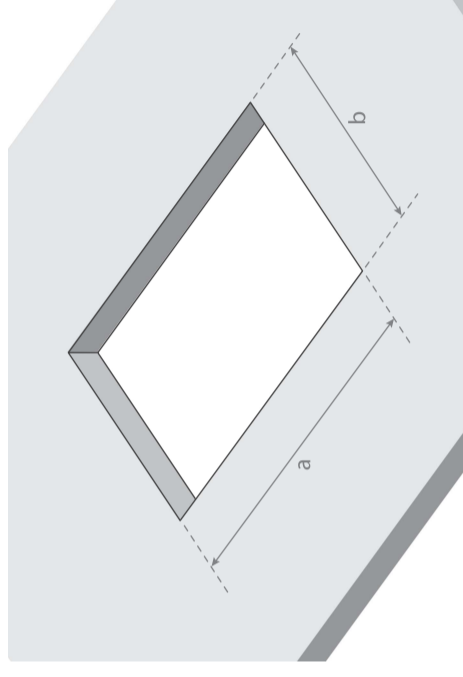

	Mounting hole dimensions		Chassis dimensions	
	length x width [a x b]		length x width [c x d]	
3-module	200 mm x 139 mm	216 mm x 149 mm	216 mm x 149 mm	66,5 mm
4-module	243 mm x 139 mm	259 mm x 149 mm	259 mm x 149 mm	
5-module	286 mm x 139 mm	302 mm x 153 mm	302 mm x 153 mm	
6-module	329 mm x 139 mm	349 mm x 153 mm	349 mm x 153 mm	
7-module	372 mm x 139 mm	420 mm x 164 mm	420 mm x 164 mm	

*+1mm / -0mm tolerance for all dimensions

Note: In case of configurations with two circuits or with UK power sockets number of available modules is lower.

Insert **magnet-Box** into the mounting hole and assembly it using mounting brackets and use M5 screws to fix it to the desk.

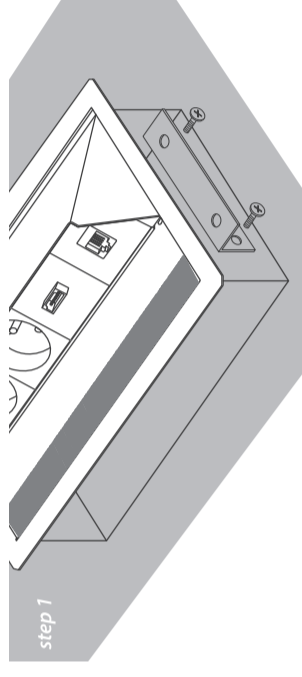

step 1

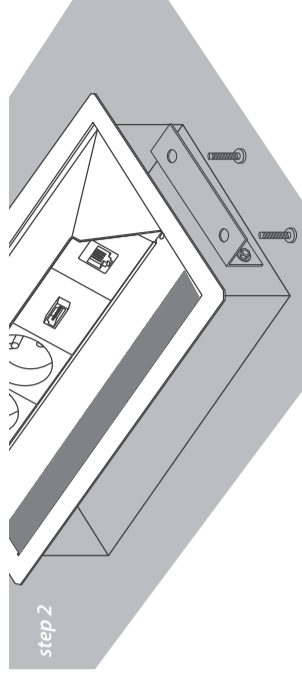

step 2

Assembling to the table top / desk of up to 30 mm thickness.

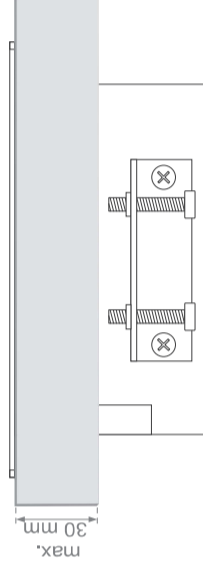

max.
30 mm.

Assembling to the table top / desk of up to 50 mm thickness.

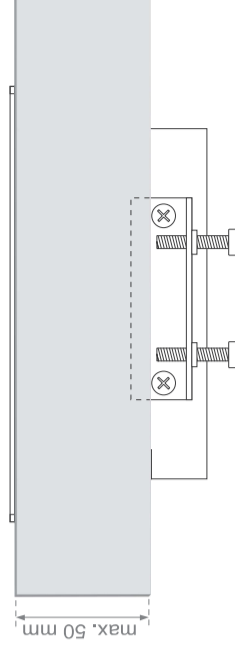

max.
50 mm.



WHITE
(RAL9003)

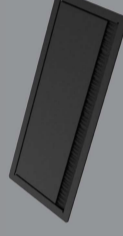

BLACK
(RAL9005)



GREY
(RAL9006)



STAINLESS STEEL
(INOX)



CHROMED-PLATED STEEL
(CHROME)